

## Innenöffner durch das Mauerwerk für Kunststoff-Klapppläden

Innenöffner Modell 1900 B

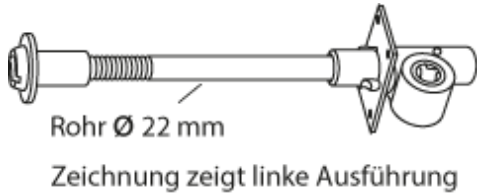

Schraubkloben 1980

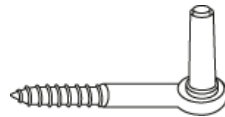

Ladenwinkel

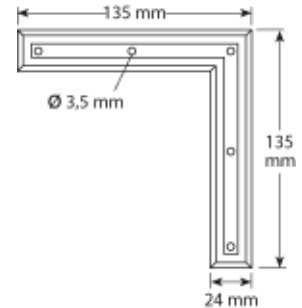

Winkelband 1570/1900

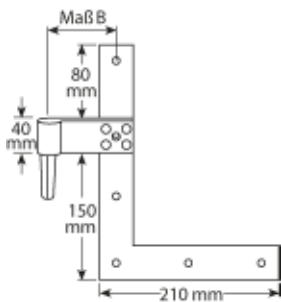

Winkelband 1570

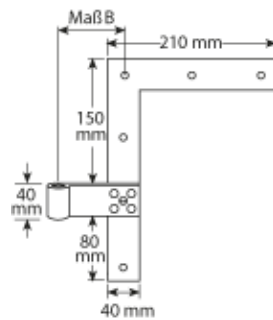

Winkelmitteband (Mitte Türflügel)

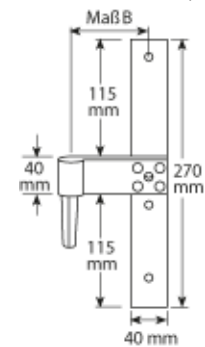

Kupplung 1910



Ladenscharnier 1579 S

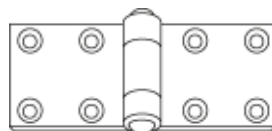

Kunststoff-Kurbel 1908

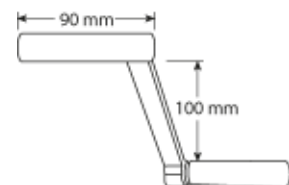

Anschlagknopf

